

**Rasonic**  
**樂信牌**

**REN-GLG10**

**10升多士焗爐 10L Toaster Oven**



**僅供家庭使用**  
**For household use only**

## **使用說明書**

# **OPERATION MANUAL**

- 在使用本產品前，請仔細閱讀本說明書，閱讀後小心收藏，以備日後查閱。  
Please read the operation manual carefully before using. Keep it in a safe place for future reference.
- 本說明書中的圖示可能與實物有不同的地方，僅供參考。  
The images in the operation manual may not match with the real object and are for reference only.

非常感謝您選購樂信牌多士焗爐，使用前請詳細閱讀本說明書，並保存以備日後參考。

## 目錄



1. 安全注意事項
2. 保養、清潔及儲存
3. 產品規格
4. 產品說明
5. 首次使用
6. 使用方法
7. 特別聲明
8. 售後服務

REN-GLG10 | 多士焗爐 Toaster Oven



## 1. 安全注意事項

使用本產品時，必須遵守下列安全預防措施：

下圖表示由於錯誤操作而引起不同程度的危險等級。

















	<b>警告：</b> 此標誌表示可能造成傷亡。
	<b>注意：</b> 此標誌表示可能造成傷害或財物損失。

以下不同標誌區分各種必須遵守的指示。

	此標誌表示禁止。
	此標誌表示必須遵守。

 注意			
	使用時或剛使用後，切勿接觸多士焗爐灼熱部分如外殼、玻璃門、烤盤、烤網或發熱管等，以免燙傷。		剛使用後，發熱管會有餘熱，請勿接觸，以免燙傷。
	如長期不使用，發熱管可能會積聚油漬，再次使用時可能會產生大量油煙，此乃正常現象。		接觸灼熱部分時，應使用隔熱手套，以免燙傷。
	烤焗會釋出油脂或有醬汁的食物時（如生肉、炸物等），請用錫紙包裹食物及必須將其放於烤盤上，避免因食物濺出的油脂或醬汁接觸發熱管而起火。請確保錫紙沒有接觸到發熱管，以免發生火災。		如多士焗爐發生冒煙或起火現象，請保持爐門緊閉，以免因遇上空氣而加大火勢。然後在安全的情況下，立即拔去電源插頭或關掉屋內電源總開關。切勿用水滅火，以免玻璃門爆裂。
	請確保多士焗爐上方、四周及背面最少有10厘米的散熱空間，切勿在櫥櫃或櫥架下方使用。		切勿使用任何物品遮蓋多士焗爐表面或散熱位，特別是金屬物件、難於散熱或易燃物料，避免過熱而導致故障。
	切勿在電源線纏結的情況下使用或將電源線懸掛在桌子、櫥櫃的邊緣或讓它接觸灼熱的表面，否則會損害電源線。		切勿將重物或剛從焗爐取出的灼熱容器擺放在打開的爐門玻璃上，以免造成玻璃爆裂。
	不可在電源線上放重物、夾住、改裝、用力拉扯或扭曲電源線。		在插入或拔除插頭時，應手握穩插頭，不要抓住電源線。
	使用前，確保碎屑盤已關妥，以免燒焦檯面及引起火災。		使用後，請拔出插頭及待多士焗爐冷卻後才移動、清潔或檢查。

 警告

	為免危險，請按照此說明書使用多士焗爐，切勿在室外使用或用作焗食物以外的其他用途。如錯誤操作，可造成傷害。		切勿焗塗有牛油或果醬的麵包或在烤盤上塗油，避免產生油煙或引起火災。
	切勿與其他高功率的電器共用同一插座；或超額使用電線拖板；或使用220V以外的電源，以免電力負荷過重及造成危險。		此多士焗爐只可供家庭或類似環境使用，如商店內部、辦事處和其他工作環境的員工廚房區域；旅館、汽車旅館和其他住宿類型的環境。
	切勿將易燃物料(如紙類或卡片等)或密封容器(如塑膠、罐類或玻璃瓶等)放入多士焗爐中進行焗。		請確保多士焗爐連接於帶接地綫的插座。為避免危險，切勿在多士焗爐加裝定時開關或獨立的遙控系統來操作。
	切勿讓多士焗爐在無人看管下運作。		手濕時切勿接觸、插入或拔除插頭，否則可構成觸電的危險。
	切勿使用有殘缺或鬆動的插座。使用前，確保插頭已充分擦乾及已插緊。		切勿把多士焗爐、電源線或插頭浸入水中；或被水濺濕，以免造成觸電或火災。
	切勿讓小孩單獨使用、清潔及維修保養多士焗爐，或把其當作玩具。請將多士焗爐及其電源線放於小孩不能觸及的地方。		此多士焗爐可供年齡在8歲或以上的兒童及體質、感覺或智力有障礙人士或缺乏經驗和相關知識的人士使用，但他們必須接受負責安全人士的監督或指導如何安全地使用多士焗爐和理解所涉及的危險。
	切勿擅自改裝多士焗爐或使用非生產商提供的原裝零件進行維修，否則可能造成危險及維修保養將無效。		使用後，應將插頭從插座內拔出，以免因絕緣老化而發生漏電。
	經常檢查多士焗爐、電源線及插頭，如有損壞，為避免危險，應立即停止使用，並聯絡信興電器服務中心有限公司安排檢查及維修。		切勿在以下環境使用多士焗爐： <ul style="list-style-type: none"> <li>- 潮濕或近水的環境</li> <li>- 靠近熱源如電焗爐、電磁爐及火源</li> <li>- 不平穩的表面上</li> <li>- 易燃物料或不耐熱物品附近(如枱布、窗簾及毛巾等)</li> </ul>

## 2. 保養、清潔及儲存

1. 清潔前，必須先拔出電源插頭，並待多士焗爐完全冷卻。
2. 每次使用後，必須清潔多士焗爐內腔、烤網及烤盤，避免油脂或渣滓積聚導致使用時產生油煙或造成侵蝕。再次使用前，必須擦乾多士焗爐、插頭及所有配件。
3. 清潔烤盤及烤網時，可用軟抹布或海綿沾上中性清潔劑清洗，再用水沖洗後抹乾。
4. 此多士焗爐底部安裝了下拉式碎屑盤。每次使用後，請向下拉出碎屑盤並用濕軟抹布清潔。清潔及抹乾後，必須將碎屑裝回焗爐底部才可再次使用。
5. 清潔多士焗爐外殼及內腔時，可用濕軟抹布清潔，然後再擦乾。切勿使用粗糙的潔具(如鋼絲刷)清潔。
6. 切勿使用有毒或含腐蝕性清潔劑進行清潔。
7. 儲存時，請將多士焗爐放入紙箱及放置在乾爽的環境中。
8. 儲存時，切勿將電源線纏繞在多士焗爐四周或壓住電源線，避免造成電源線損壞。

## 3. 產品規格

型號	REN-GLG10
額定電壓	220伏特~ 50-60赫茲
額定功率	1,000瓦
容量	10升
溫度控制	100-230°C (+/- 30°C為正常溫差範圍)
淨重	2.90公斤
爐內尺寸(闊 x 深 x 高)	260 x 233 x 167毫米
產品尺寸(闊 x 深 x 高)	365 x 280 x 200毫米

## 4. 產品說明

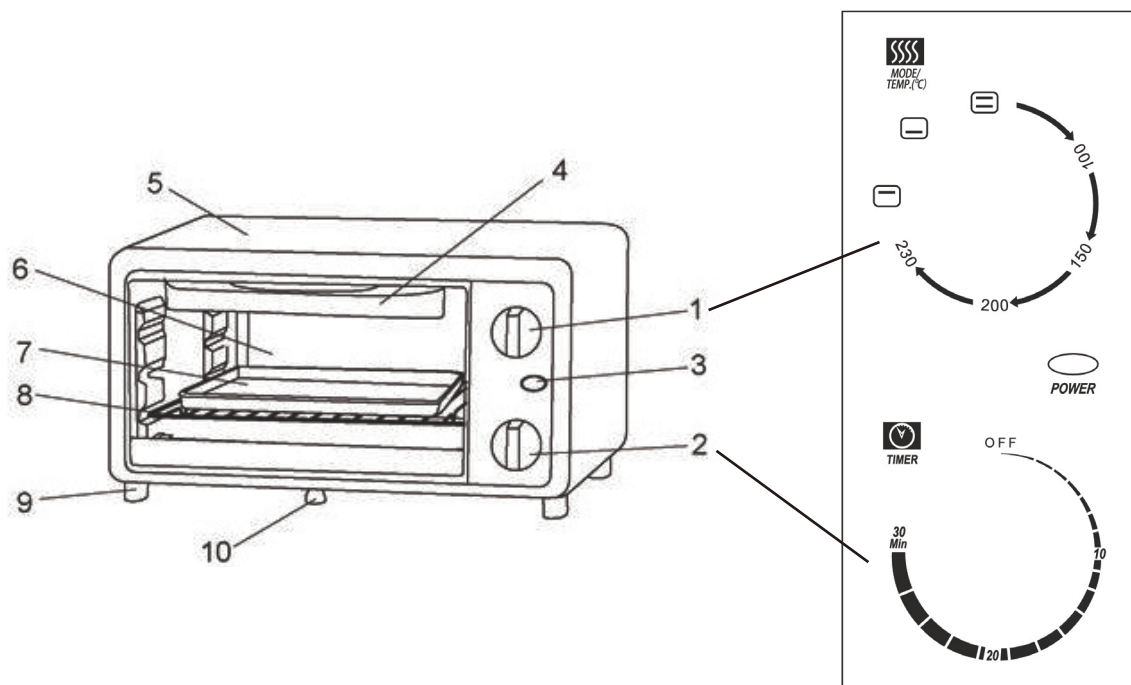

(以上產品圖片僅供參考，外觀以實物為準。)

### 1. 功能 / 溫度旋鈕

功能	說明
	只啟動上發熱管，不設溫度選擇。
	只啟動下發熱管，不設溫度選擇。
	啟動上下發熱管，並設溫度選擇：100 – 230°C。

2. 時間旋鈕
3. 電源指示燈
4. 爐門手柄
5. 外殼
6. 玻璃爐門
7. 烤盤
8. 烤網
9. 爐腳
10. 下拉式碎屑盤

## 5. 首次使用

首次使用前，請按以下步驟進行空燒，以清除新機的氣味：

1. 連接電源前，請檢查【時間】旋鈕在OFF(關)的位置。
2. 將【功能 / 溫度】旋鈕設定在230°C，並把【時間】旋鈕設定為10分鐘，空燒時可能會有煙霧及氣味，此屬正常現象。
3. 空燒後，必須待多士焗爐完全冷卻後才可使用。

## 6. 使用方法

1. 請確定【時間】旋鈕在OFF(關)的位置，將電源插頭插入插座。
2. 將食物平均地放置在烤網或烤盤上，再放入爐內。  
※ 注意：如烹調面積較細小的食物時，請確保食物不會從烤網空隙跌出，或建議使用烤盤。
3. 將【功能 / 溫度】旋鈕設定到所需功能或溫度。  
※ 注意：發熱管會間斷地亮起以調整溫度，此乃正常現象。
4. 將【時間】旋鈕設定到所需烹調時間，電源指示燈會亮起，表示多士焗爐啟動。  
※ 注意：如設定5分鐘或以下的烤焗時間，請扭動【時間】旋鈕至6分鐘或以上，再回轉至所需時間。
5. 烹調完成後，【時間】旋鈕會轉回OFF(關)的位置，多士焗爐會發出鳴聲提示。  
※ 注意：如需在烹調過程中停止烤焗，可將【時間】旋鈕回轉至OFF(關)的位置。
6. 使用後，請把電源插頭從插座拔出。

### 烹調注意事項：

1. 冷凍食物需要較長的烤焗時間，請根據實際烹調情況調整烤焗時間。
2. 烹調時間因食物的溫度、種類、份量等不同而各有差異，請根據實際情況進行調整。
3. 時常留意烤焗中的食物，避免烤焦。
4. 烘烤時，水蒸氣可能會凝聚於爐門周邊或玻璃上。這是由於食物當中的水分蒸發所造成，此為正常現象。切勿在烘烤時或多士焗爐尚有餘熱時用水擦拭玻璃爐門，否則玻璃可能會破裂。
5. 使用時，多士焗爐可能有聲音發出，這是由於加熱時物料和食物膨脹，並不表示發生故障。

## 7. 特別聲明

- 1.本資料上所有內容經過核對，如有任何印刷及內容上的誤解，本公司將保留解釋權。
- 2.本產品若有技術改進，會編進新版說明書中，恕不另行通知；產品外觀、顏色如有改動，則以製造商資料為準。
- 3.如本資料之中英文版本有差異時，應以中文版為準。
- 4.使用說明書的電子副本可以通過電子郵件發送致客戶，如有需要，可致電信興電工工程有限公司：28612767。

## 8. 售後服務

- 1.由購買收據日期起之一年保修期內，經信興電器服務中心有限公司之服務人員證實產品故障屬於正常使用之情況下發生者，本公司將提供免費維修或更換零件服務。經更換之任何損壞零件，將歸屬本公司所有。保修範圍不包括修理或更換產品之損耗性零件等。
- 2.用戶必須於維修時出示購買收據/換購收據及蓋有銷售點/換購中心印章的產品保修記錄卡。如有任何疑問，請致電信興電器服務中心有限公司熱線：24065666查詢。

Thank you for choosing Rasonic Toaster Oven. Please read the operation manual carefully before use and keep it for your future reference.

## Table of Contents



1. Important Safeguards
2. Maintenance, Cleaning and Storage
3. Product Specifications
4. Product Descriptions
5. First Use
6. Operation Instructions
7. Special Avowal
8. After Sales Service

REN-GLG10 | 多士焗爐 Toaster Oven



## 1. Important Safeguards















When using the appliance, please follow the below safety precautions:

The following chart indicates the degree of damage caused by wrong operation.

















	<b>WARNING:</b> Indicates that may cause death or severe injury.
	<b>CAUTION:</b> Indicates hazards that may cause human injuries or property damages.

The following symbols can distinguish the instruction types that need to be strictly followed.

	These symbols mean prohibition.
	These symbols mean requirement that must be followed.

 CAUTION			
	When the appliance is in use or just after use, do not touch the hot parts such as the housing, glass door, bake tray, bake rack or heating elements etc, to avoid burns.		There is residual heat on the heating elements after use. Do not touch to avoid burns.
	If the appliance is not in use for a period, grease may accumulate on the heating element. Excessive smoke may occur when it is used again which is normal.		When touch the hot part, always wear the oven gloves to avoid getting burns.
	When cooking foods which are greasy or marinated with sauce (e.g. raw meat, deep fried food), please wrap the food with aluminum foil and put them on the bake tray. It is to avoid the food grease or sauces from spilling onto the heating elements and cause fire. Make sure the aluminum foil does not touch the heat elements to avoid fire.		If the appliance smoke or catch fire, please keep the oven door closed as air will trigger the fire to burn more vigorously. You should disconnect the power source at once or turn off the master switch under a safe situation. Never try to put out the fire with water to avoid the glass door crack
	Make sure there is at least 10cm clearance above the oven, on its surrounding and back for ventilation. Do not operate the appliance under a wall cupboard or shelf.		Do not cover the appliance surface or air vents with any objects especially metal objects, heat-insulated or inflammable materials. It is to avoid unit malfunction due to overheat
	Do not operate the appliance when the power cord is tangle or hang the power cord over the edge of table, counter-top or let it touch any hot surface, it may damage the power cord		To avoid glass crack, never put heavy objects or heated containers just taken out from the oven on the open glass door.
	Do not place heavy objects on the power cord. Never clip, modify, stretch or twist the power cord		Be sure to grasp the power plug itself when plug in or remove the plug, do not grasp the power cord.
	When in use, please make sure the crumb tray is installed to avoid table burns and fire.		After use, remove the plug and let the appliance completely cool down before moving, cleaning or checking.

 **WARNING**

	To avoid danger, please use the appliance according to the operation manual. Do not use it outdoors or other purpose except baking food. Misuse can cause potential injury.		Do not toast bread with butter or jam or spread oil on the bake tray to avoid smoke or fire.
	Do not use the same socket with other high wattage appliance or use the extension cord beyond its capacity. Never use power supply other than 220V to avoid overload and danger.		The appliance is intended to be used in household or similar applications such as staff kitchen in shops, offices and other working environments; by clients in hotels, motels and other residential type environments.
	Never put inflammable materials (e.g. paper or cardboard, etc) or sealed containers (e.g. plastic, cans or glass bottles, etc.) into the appliance for baking		Please make sure the appliance is connected to power socket with earth wire. To avoid hazards, never connect the appliance to a timer switch or separate remote control system.
	Never leave the appliance unattended when in use.		Do not touch, plug in or remove the plug with wet hands, it can cause electric shock.
	Do not use deficient or loosen socket. Before use, make sure the plug is dry and inserted firmly.		Never immerse the appliance, power cord or plug in water or let them wet, it can cause electric shock or fire.
	Never allow children to operate, clean perform user maintenance on the appliance alone or play it as toy. Please put the appliance and its power cord in a place not reachable by children.		The appliance can be used by children aged from 8 years and above and persons with reduced physical, sensory or mental capabilities, or lack of experience and knowledge, if they have given supervision or instruction concerning use of the appliance in a safe way and understand the hazards involved.
	Do not attempt to modify the appliance by yourself or repair with any unauthorized parts, otherwise it will cause hazards and the warranty will become invalid.		Always unplug the appliance from the power socket after use to avoid electric leakage due to insulation parts degeneration.
	Always check the condition of the appliance power cord and plug. To avoid hazards, stop using the appliance immediately and contact Shun Hing Electric Service Centre Ltd. for checking and repairing if any part is damaged		Do not operate the appliance in following places: <ul style="list-style-type: none"> <li>— Humid environment or near water</li> <li>— Near heat sources such as electric oven, induction cooker and fire</li> <li>— On unstable surface</li> <li>— Near inflammable or non-resistant to heat objects (e.g. table cloth, curtain and towel etc).</li> </ul>

## 2. Maintenance, Cleaning and Storage

1. The toaster oven must be unplugged and cooled down completely before cleaning.
2. After every use, make sure to clean the toaster oven cavity, bake rack and bake tray. It is to avoid smoke or corrosion caused by the accumulated grease or food residue. Always make sure the toaster oven, plug and all accessories are dry before use again.
3. When clean the bake tray and bake rack, please use a soft cloth or sponge soaked with mild detergent, then wash with water and wipe them dry.
4. The toaster oven is installed with a swing-down crumb tray at the bottom. After every use, please pull down the crumb tray and clean with a damp cloth. After clean and dry, make sure it is covered back to the oven bottom before use.
5. Clean the toaster oven housing and cavity by a damp cloth, then wipe them dry. Never clean with harsh tools e.g. metal-wired brush.
6. Never use poisonous or corrosive detergent to clean.
7. When store, put the toaster oven in a box and store in a dry place.
8. When store, never wrap the power cord tightly around the toaster oven or put any pressure on the power cord, it is to avoid power cord damage.

## 3. Product Specifications

Model	REN-GLG10
Rated Voltage	220V~ 50-60Hz
Rated Power	1,000 W
Capacity	10 L
Temperature Control	100-230°C (+/- 30°C as normal range)
Net Weight	2.90 Kg
Cavity Dimension (W x D x H)	260 x 233 x 167 mm
Product Size (W x D x H)	365 x 280 x 200 mm

## 4. Product Descriptions

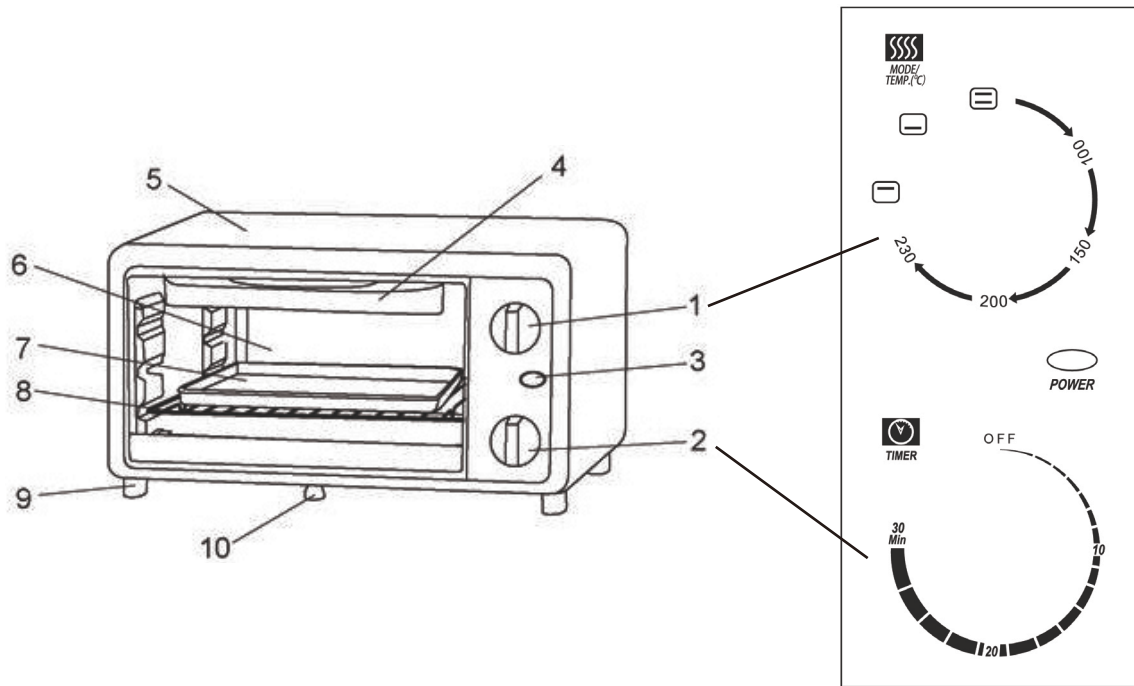

(Above product drawing is for reference only, appearance refers to actual product.)

### 1. Mode / Temp. knob

Mode	Description
	Only upper heating element is operated, temperature setting is not available.
	Only lower heating element is operated, temperature setting is not available.
	Both upper and lower heating elements are operated, temperature setting is 100–230°C.

2. Timer knob
3. Power light
4. Door handle
5. Housing
6. Door glass
7. Bake tray
8. Bake rack
9. Oven feet
10. Swing-down crumb tray

## 5. First Use

Before first use, operate the toaster oven empty to eliminate the smell of new oven by the below procedures:

1. Before connecting to the power, please check the 【Timer】 knob is at OFF position.
2. Set the 【Mode / Temp.】 knob at 230°C and the 【Timer】 knob at 10 minutes. When operate the oven empty, smoke and smell may appear which is normal.
3. After operate the toaster oven empty, make sure it cools down completely before use.

## 6. Operation Instructions

1. Please make sure the **【Timer】** knob is at OFF position, then insert the plug to the power socket.
2. Place the food on the bake rack or bake tray evenly, then put into the oven.  
 ※ Note: If small-sized food is to be cooked, please make sure it will not fall out of the gaps of bake rack, or use the bake tray alternatively.
3. Turn the **【Mode / Temp.】** knob to set the mode or temperature.  
 ※ Note: The heating element will light up intermittently to adjust the temperature which is normal.
4. Turn the **【Timer】** knob to set the cooking time, the power light turns on which indicates the toaster oven is operated.  
 ※ Note: To set the cooking time of 5 minutes or below, please turn the **【Timer】** knob over 6 minutes or above, then turn back to the needed cooking time.
5. After cook, the **【Timer】** knob will return to the OFF position, the toaster oven will have a bell sound.  
 ※ Note: If you need to stop the cooking process, please turn the **【Timer】** knob back to the OFF position.
6. After use, please unplug the toaster oven from the power socket.

### Cooking Precautions:

1. Frozen food may take longer time to cook, please adjust the cooking time according to the actual cooking condition.
2. The cooking time is varied with different food temperature, types, quantity etc. Please adjust it according to the actual cooking condition.
3. Always pay attention to the food during cooking to avoid overcook.
4. When cooking, water vapor may condense around oven door or on the door glass. This is because water evaporates from the food which is normal. Never rub the glass door with water during operation or when there is residual heat, otherwise the glass may crack.
5. There may have sounds when the toaster oven is operating, it is due to heat expansion of material and food, it does not indicate any malfunction.

## 7. Special Avowal

1. The content in the operation manual has been checked. Our company reserves the hermeneutic power to any printing errors or misunderstanding on the content.
2. If there are technical improvements on the appliance, the operation manual will be updated in new version without prior notice. The product appearance and specification are subject to the manufacturer information.
3. In case there is any inconsistency or conflict between the English versions and Chinese versions of the terms, the Chinese versions shall prevail.
4. The e-copy of user manual can be sent by email on requested. For enquiries, please call Shun Hing Electric Works & Engineering Co., Ltd. hotline at 2861 2767.

## 8. After Sales Service

1. For any defect, in the judgement of technician from Shun Hing Electric Service Center Limited, caused under normal use, our company is responsible for repairing or replacing parts of the said electrical appliance free of charge within one year guarantee period commencing from the date of purchase. Any defect part which has been replaced shall become our property. Guarantee service does not cover the repair or replacement of consumable parts etc.
2. User must present the official invoice/redemption voucher and the product warranty card with the chop from sales point/redemption center for maintenance. For enquiries, please call Shun Hing Electric Service Center Limited hotline at 2406 5666.



**Rasonic 樂信牌**

## 信興電工工程有限公司

**SHUN HING ELECTRIC WORKS AND ENGINEERING CO., LTD.**

辦公室：香港九龍尖沙咀東部麼地道67號半島中心9樓

電話：2861 2767

圖文傳真：2865 6706

網址：<http://www.rasonic.com>

電郵：[shew@shunhinggroup.com](mailto:shew@shunhinggroup.com)

Office: 9/F, Peninsula Centre, 67 Mody Road, Tsimshatsui East, Kowloon, H.K.

Tel: 2861 2767

Fax: 2865 6706

Website: <http://www.rasonic.com>

E-mail: [shew@shunhinggroup.com](mailto:shew@shunhinggroup.com)

保養及維修 Maintenance and Repair Service:

## 信興電器服務中心有限公司

**SHUN HING ELECTRIC SERVICE CENTRE LTD.**

香港新界葵涌勝耀街2號信興中心11樓

電話：2406 5666

圖文傳真：2408 0316

網址：<http://www.shesc.com/zh>

11/F, Shun Hing Centre, 2 Shing Yiu Street, Kwai Chung, N.T. H.K.

Tel: 2406 5666

Fax: 2408 0316

Website: <http://www.shesc.com/en>

客戶服務中心

香港新界葵涌勝耀街2號信興中心1樓

九龍尖沙咀東部麼地道67號半島中心B座9樓

香港天后琉璃街7號柏景中心22樓

澳門慕拉士大馬路193-199號南嶺工業大廈5樓I座

Customer Service Centre

1/F, Shun Hing Centre, 2 Shing Yiu Street, Kwai Chung, N.T.

9/F, Block B, Peninsula Centre, 67 Mody Road, Tsim Sha Tsui East, Kowloon

22/F, Parkview Centre, 7 Lau Li Street, Tin Hau, Hong Kong

Avenida de Venceslao de Morais, No. 193-199, 5 andar - 1, Edf. Industrial Nam

Leng, Macau

有關最新之香港及澳門客戶服務中心資料，請參閱信興服務中心網址：

<http://www.shesc.com/zh>

For the latest information of Hong Kong and Macau service center, please visit

<http://www.shesc.com/en>

REN-G0623